



Owner's Manual

Original Instructions

Commercial Air Conditioners

Multi Variable Air Conditioners Fresh Air Series Indoor Unit

Models:

GMV-NX140P/A(X1.2)-K

GMV-NX224P/A(X2.0)-M

GMV-NX280P/A(X2.5)-M

GMV-NX280P/A(X3.0)-M

GMV-NX450P/A(X4.0)-M

Thank you for choosing commercial air conditioners. Please read this Owner's Manual carefully before operation and retain it for future reference.

If you have lost the Owner's Manual, please contact the local agent or visit www.gree.com or send an email to global@cn.gree.com for the electronic version.

GREE ELECTRIC APPLIANCES, INC. OF ZHUHAI

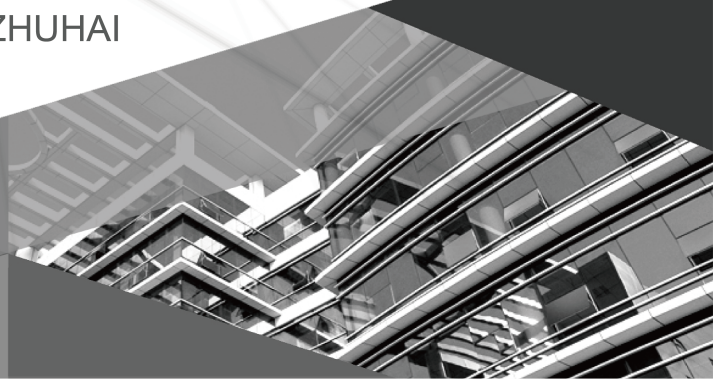

To Users

Thank you for selecting Gree product. Please read this instruction manual carefully before installing and using the product, so as to master and correctly use the product. In order to guide you to correctly install and use our product and achieve expected operating effect, we hereby instruct as below:

- (1) This appliance can be used by children aged from 8 years and above and persons with reduced physical, sensory or mental capabilities or lack of experience and knowledge if they have been given supervision or instruction concerning use of the appliance in a safe way and understand the hazards involved. Children shall not play with the appliance. Cleaning and user maintenance shall not be made by children without supervision.
- (2) In order to ensure reliability of product, the product may consume some power under stand-by status for maintaining normal communication of system and preheating refrigerant and lubricant. If the product is not to be used for long, cut off the power supply; please energize and preheat the unit in advance before reusing it.
- (3) Please properly select the model according to actual using environment; otherwise it may impact the using convenience.
- (4) This product can't be installed at corrosive, inflammable or explosive environment or the place with special requirements, such as kitchen. Otherwise, it will affect the normal operation or shorten the service life of the unit, or even cause fire hazard or serious injury. As for above special places, please adopt special air conditioner with anti-corrosive or anti-explosion function.
- (5) If the product needs to be installed, moved or maintained, please contact our designated dealer or local service center for professional support. Users should not disassemble or maintain the unit by themselves, otherwise it may cause relative damage, and our company will bear no responsibilities.
- (6) All the illustrations and information in the instruction manual are only for reference. In order to make the product better, we will continuously conduct improvement and innovation. If there is adjustment in the product, please subject to actual product.

Exception Clauses

Manufacturer will bear no responsibilities when personal injury or property loss is caused by the following reasons:

- (1) Damage the product due to improper use or misuse of the product;
- (2) Alter, change, maintain or use the product with other equipment without abiding by the instruction manual of manufacturer;
- (3) After verification, the defect of product is directly caused by corrosive gas;
- (4) After verification, defects are due to improper operation during transportation of product;
- (5) Operate, repair, maintain the unit without abiding by instruction manual or related regulations;
- (6) After verification, the problem or dispute is caused by the quality specification or performance of parts and components that produced by other manufacturers;
- (7) The damage is caused by natural calamities, bad using environment or force majeure.

Contents

1 Safety Notices (Please be sure to abide them)	1
2 Product Introductions	3
2.1 Unit Introduction	3
2.2 Rated Working Condition.....	5
2.3 Working Temperature Range.....	5
3 Preparations for Installation	5
3.1 Standard Fittings.....	6
3.2 Location for Installation.....	6
3.3 Requirements for Communication Line	7
3.4 Wiring Requirements	8
4 Installation Instructions	9
4.1 Installation of Indoor Unit.....	9
4.2 Pipe Connection	12
4.3 Installation and Test of Drain Pipe	12
4.4 Installation of Air Duct.....	15
4.5 Installation of Wired Controller	19
5 Wiring Work	19
5.1 Connection of Wire and Patch Board Terminal.....	20
5.2 Power Cord Connection	21
5.3 Connection of Communication Line of IDU and ODU	21
5.4 Connect Communication Wire of Wired Controller	22
5.5 Illustrate for Connection of Wired Controller and Indoor Units Network	23
6 Routine Maintenance	25
6.1 Cleaning of Filter	25
6.2 Maintenance before the Seasonal Use	25
6.3 Maintenance after the Seasonal Use	25
7 The Table of Error Codes for Indoor Unit	25
8 Troubleshooting	26

1 Safety Notices (Please be sure to abide them)



WARNING: If not abide them strictly, it may cause severe damage to the unit or the people.



NOTE: If not abide them strictly, it may cause slight or medium damage to the unit or the people.



This sign indicates that the items must be prohibited. Improper operation may cause severe damage or death to people.











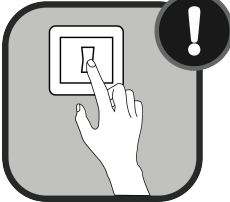

This sign indicates that the items must be observed. Improper operation may cause damage to people or property.

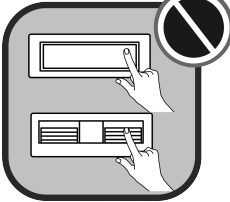

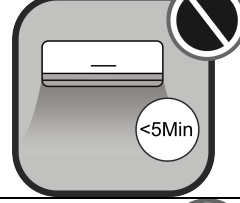
WARNING!

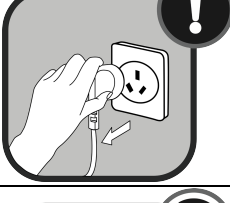
This product can't be installed at corrosive, inflammable or explosive environment or the place with special requirements, such as kitchen. Otherwise, it will affect the normal operation or shorten the service life of the unit, or even cause fire hazard or serious injury. As for the above special places, please adopt special air conditioner with anti-corrosive or anti-explosion function.

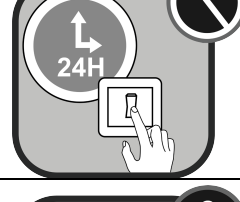
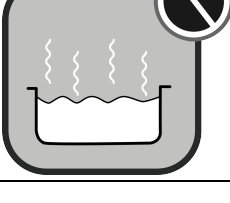
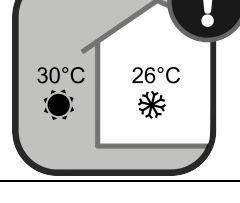
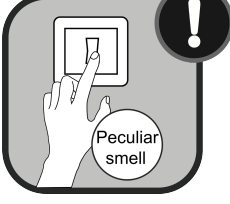
	<p>Follow this manual to complete the installation work. Please read this manual carefully before turning on or repairing the unit.</p>		<p>Installation should be conducted by the dealer or qualified personnel. Please do not attempt to install the air conditioner by yourself. Improper installation may lead to water leakage, electric shock or fire hazard, etc.</p>
	<p>Before installation, please check whether the power supply is complied with that specified on the nameplate and check the safety of the power supply.</p>		<p>The air conditioner must be grounded reliably for avoiding electric shock. Please do not connect the earthing wire to gas pipe, water pipe, lightning rod or telephone line.</p>
	<p>Be sure to use special accessories and parts for installation to prevent water leakage, electric shock and fire hazard, etc.</p>		<p>If refrigerant leakage happens, please ventilate the room immediately.</p>
	<p>Diameter of power cord should be large enough. The damaged power cord and connection wire must be replaced with special cables.</p>		<p>When the power cord is connected, please fix the electric box cover properly to avoid safety accidents.</p>
	<p>Never fail to comply with the nitrogen-charging welding process. Do charge nitrogen when welding the pipes.</p>		<p>Never short circuit or cancel the pressure switch to prevent unit damage.</p>

	<p>As for the unit controlled by the wired controller, connect the wired controller well firstly and then energize the unit; otherwise, the unit can't operate normally.</p>		<p>When installation is finished, please check whether the drainage pipes, pipelines and electric wires are connected correctly to avoid water leakage, refrigerant leakage, electric shock or fire, etc.</p>
	<p>Do not insert fingers or objects into air outlet or air return grille.</p>		<p>Open the door and window frequently to keep good ventilation for avoiding oxygen deficit when gas heater or oil heater is used in the room.</p>
	<p>Never plug in or unplug the power plug directly to turn on or turn off the air conditioner.</p>		<p>Once the air conditioner is turned on, it can be turned off only after it has operated for 5min at least; otherwise, it will affect the oil return of compressor.</p>
	<p>Do not allow children to operate this air conditioner.</p>		<p>Do not operate this air conditioner with wet hands.</p>
	<p>The air conditioner can be cleaned only when it has been turned off and the power has been cut off; otherwise, it may cause electric shock or injury.</p>		<p>Never spray or flush water towards the air conditioner; otherwise, malfunction or electric shock may happen.</p>
	<p>Do not expose the air conditioner to the moist or corrosive environment.</p>		<p>Put through the power 8 hours in advance before operation. Do not cut off the power when the air conditioner stops operation for only about one night (protect the compressor).</p>
	<p>Volatile liquid, such as diluent or gasoline, will damage the appearance of air conditioner. Only soft dry cloth and wet cloth dipped with neutral detergent can be used to clean the outer case of air conditioner.</p>		<p>Under cooling mode, please don't set the room temperature too low; keep the temperature difference between indoor and outdoor within 5°C (41°F).</p>
	<p>If there are any abnormal circumstances (such as burning smell, etc.), please turn off the unit and cut off the main power supply immediately, and then contact Gree appointed service center. If those abnormal circumstances still exit, the unit may be damaged and it may lead to electric shock or fire hazard.</p>		<p>Do not repair the unit by yourself. Wrong maintenance may cause electric shock or fire hazard. Please contact Gree appointed service center for help.</p>

Any personal injury or property loss caused by improper installation, improper debug, and unnecessary repair or not following the instructions of this manual should not be the responsibility of Gree Electric Appliances, Inc. of Zhuhai.

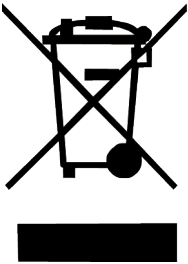
	<p>Correct Disposal of this product</p>
	<p>This marking indicates that this product should not be disposed with other household wastes throughout the EU. To prevent possible harm to the environment or human health from uncontrolled waste disposal, recycle it responsibly to promote the sustainable reuse of material resources. To return your used device, please use the return and collection systems or contact the retailer where the product was purchased. They can take this product for environmental safe recycling.</p>

2 Product Introductions

2.1 Unit Introduction

VRF fresh air series indoor unit is a kind of air processing unit that inhales the fresh air from outdoor side and then processes it to provide for the user in the room. Fresh air series indoor unit have three kinds of connection according to different models:

- (1) If the number of connected indoor units is more than one and connecting with conventional VRF indoor units:

Optional indoor unit model	Connected outdoor unit series	Connection condition
GMV-NX140P/A(X1.2)-K GMV-NX224P/A(X2.0)-M GMV-NX280P/A(X2.5)-M GMV-NX280P/A(X3.0)-M	GMV5 GMV6	1) The total capacity of connected fresh air indoor units cannot exceed 50%~100% of the capacity of outdoor units; 2) The total capacity of connected fresh air indoor units cannot exceed 30% of the capacity of outdoor units.

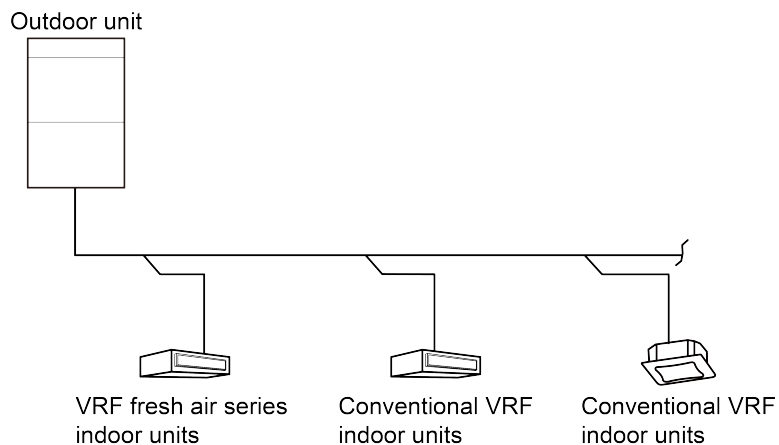

Fig 2.1.1 Connection diagram of outdoor unit is a single module

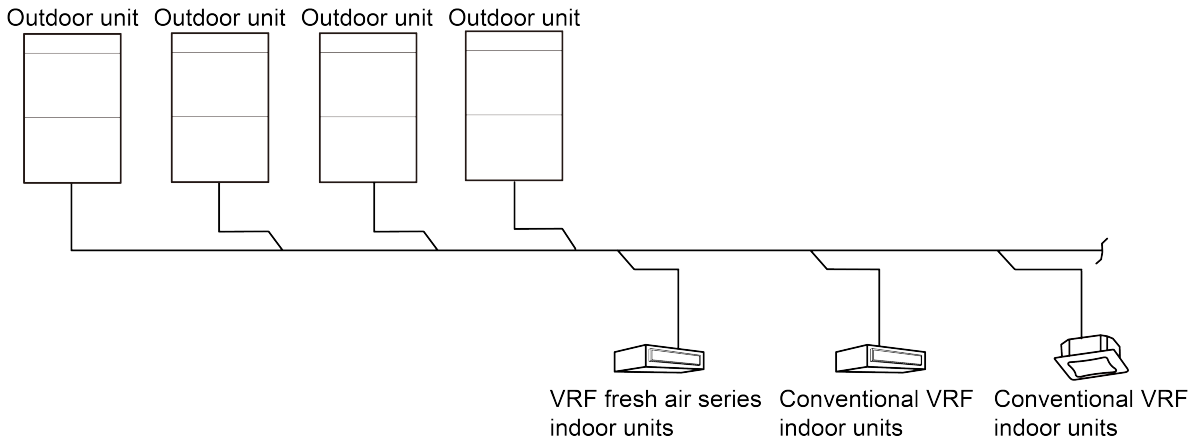

Fig 2.1.2 Connection diagram of outdoor units is modular

(2) If the number of connected indoor units is more than one and all of them are VRF fresh air indoor units:

Optional indoor unit model	Connected outdoor unit series	Connection condition
GMV-NX140P/A(X1.2)-K GMV-NX224P/A(X2.0)-M GMV-NX280P/A(X2.5)-M GMV-NX280P/A(X3.0)-M	GMV5 GMV6 GMV Slim*	The total capacity of connected fresh air indoor units cannot exceed 50%~100% of the capacity of outdoor units.
GMV-NX450P/A(X4.0)-M	GMV5 GMV6	1) Cannot match with other models of indoor units; 2) The total capacity of connected fresh air indoor units cannot exceed 50%~100% of the capacity of outdoor units.

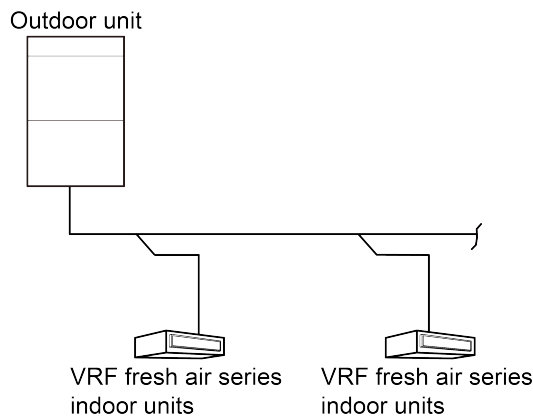

Fig 2.1.3 Connection diagram of outdoor unit is a single module

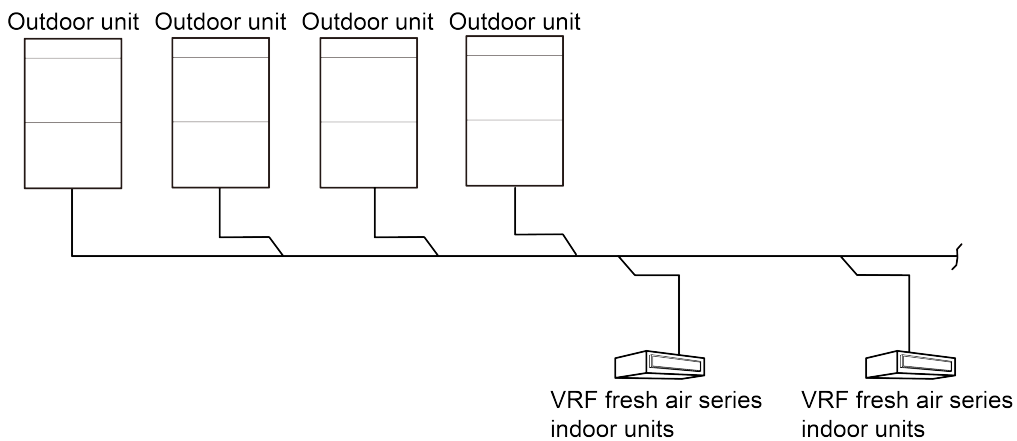

Fig 2.1.4 Connection diagram of outdoor units is modular

(3) If the number of connected indoor units is only one and it is VRF fresh air indoor unit:

Optional indoor unit model	Recommended capacity of outdoor unit	Connected outdoor unit series	Connection condition
GMV-NX140P/A(X1.2)-K	14kW	GMV Mini*	The capacity of outdoor unit is not less than the recommended capacity and cannot exceed 10% of the recommended capacity.
GMV-NX224P/A(X2.0)-M	22.4kW	GMV5	
GMV-NX280P/A(X2.5)-M	28kW	GMV6	
GMV-NX280P/A(X3.0)-M	28kW	GMV Slim*	
GMV-NX450P/A(X4.0)-M	45kW	GMV5 GMV6	

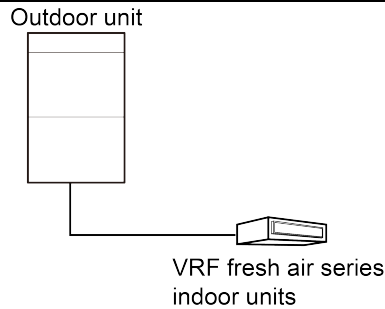

Fig 2.1.5 Connection diagram of only one VRF fresh air indoor unit system

NOTES!

- ① Please match the outdoor unit in strict accordance with the above requirements, otherwise, the comfortableness will be affected or even the unit will be damaged.
- ② If the VRF fresh air indoor unit match with GMV Slim series or GMV Mini series, please consult technical staffs for details.

2.2 Rated Working Condition

	Indoor Side Condition		Outdoor Side Condition	
	Dry Bulb Temp(°C)	Wet Bulb Temp(°C)	Dry Bulb Temp(°C)	Wet Bulb Temp(°C)
Rated Cooling	35	28	35	28
Rated Heating	7	6	7	6

2.3 Working Temperature Range

	Outdoor Ambient Dry Bulb(°C)
Working Temperature Range	-7~45

NOTE!

The ex-factory set temperature is 18°C in cooling mode and 22°C in heating mode. If the user needs to change the temperature setting, please contact after-sales service personnel.



3 Preparations for Installation

NOTE!

Product graphics are only for reference. Please refer to actual products. Unspecified measure unit is mm.

3.1 Standard Fittings

Please use the supplied standard fittings listed below as instructed.

No.	Name	Graphics	Quantity	Function
1	Wired Controller		1	Control indoor unit
2	Union Nut Sub-assy		1	Connect exit pipe

! NOTE!

The packed attachments should be subject to actual objects. If there are any alterations, there will be no further notice.

3.2 Location for Installation

- (1) The top holder must be strong enough to support unit's weight.
- (2) Drain pipe can drain water out easily.
- (3) There is no obstacle at inlet or outlet. Please ensure good air circulation.
- (4) In order to make sure the space for maintenance, please install the indoor unit according to the dimension described below.
- (5) Keep the unit away from heat source, inflammable gas or smoke.
- (6) This is a concealed ceiling type unit.
- (7) Indoor unit, outdoor unit, power cord and electric wire should stay at least 1m from the TV set and radio. Otherwise, these electric appliances may have image interference and noise (Even if the distance is 1m, when there is strong electric wave, noise may still occur).

Unit: mm

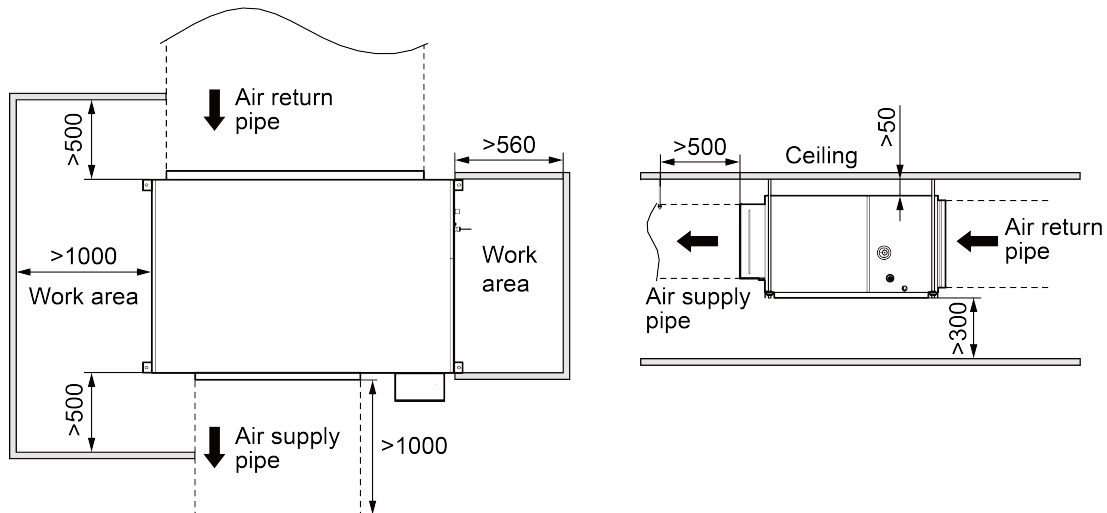

Fig.3.2

! NOTES!

- ① Installation of the unit must be in accordance with National Electric Codes and local safety regulations.

- ② Improper installation will affect unit's performance, so do not install the unit by yourself. Please contact local dealer to arrange professional technicians for the installation.
- ③ Do not connect power until all installation work is finished.

3.3 Requirements for Communication Line



If the unit is installed in the place with strong electromagnetic interference, shielded wire must be applied on the communication wire between indoor unit and wired controller. Twisted pair line with shielding function must be applied on the communication wire between indoor unit and indoor unit (outdoor unit).

3.3.1 Select communication line for indoor unit and wired controller

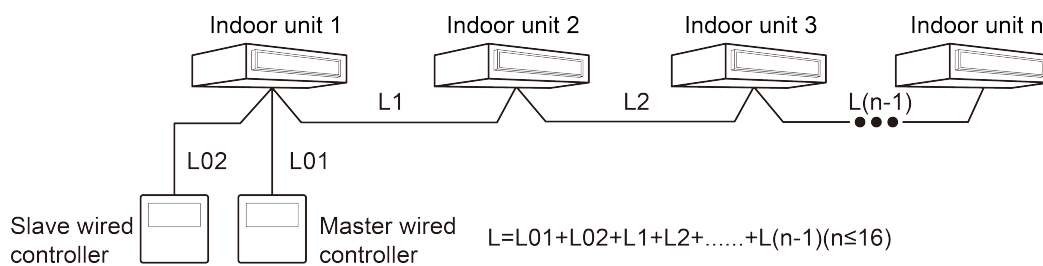

Fig.3.3.1

Wire Type	Total Length of Communication Line L(m)	Numbers × Size (mm ²)	Wire Standard	Remark
Light/Common PVC Jacket Soft Wire	L≤250	2×0.75~2×1.25	IEC 60227-5	The total length of communication line should not exceed 250m

3.3.2 Select communication line for indoor unit and indoor unit (outdoor unit)

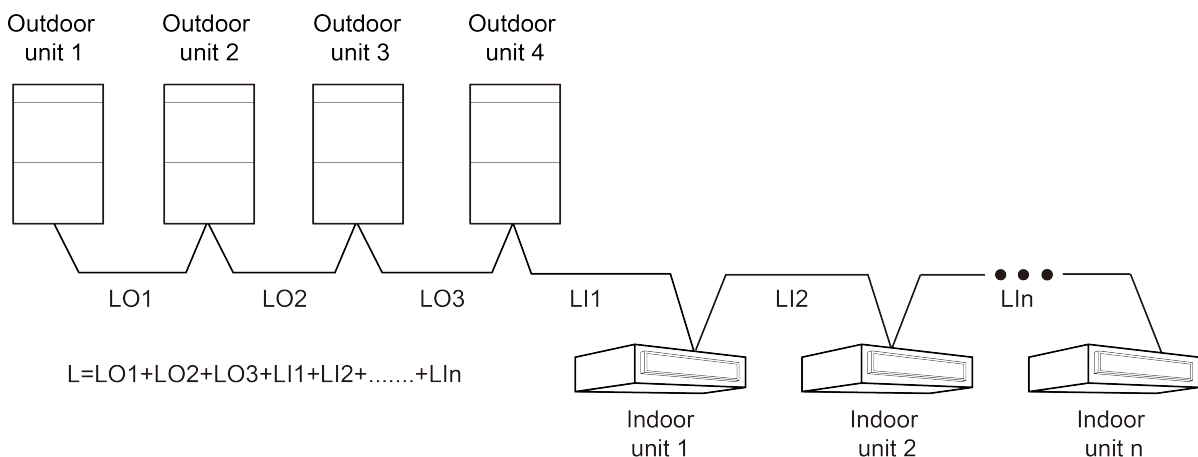

Fig.3.3.2

Wire Type	Total Length of Communication Line L(m)	Numbers × Size (mm ²)	Wire Standard	Remark
Light/Common PVC Jacket Soft Wire	L≤1000	≥2×0.75	IEC 60227-5	If wire gauge is 2×1 mm ² , then it's OK to increase the length of communication line. But total length should not exceed 1500m.

3.4 Wiring Requirements

(1) Power Cord Size and Air Switch Capacity

Model	Power Supply	Air Switch Capacity (A)	Minimum Sectional Area of Ground Wire(mm ²)	Minimum Sectional Area of Power Cord(mm ²)
GMV-NX140P/A(X1.2)-K	220-240V ~50Hz	6	1.0	1.0
GMV-NX224P/A(X2.0)-M	380-415V 3N~50Hz	6	1.0	1.0
GMV-NX280P/A(X2.5)-M	380-415V 3N~50Hz	6	1.0	1.0
GMV-NX280P/A(X3.0)-M	380-415V 3N~50Hz	6	1.0	1.0
GMV-NX450P/A(X4.0)-M	380-415V 3N~50Hz	6	1.0	1.0

NOTES!

- ① The size of circuit breaker and power cord in above sheet is selected based on the max power (max current) of unit.
 - ② Above selection requirements of power cord size: Power cord size is based on multicore copper core cable with operation temperature of 90°C when laying on wire groove at 40°C ambient temperature (IEC 60364-5-523). If the operation condition is different, please calculate according to national standard.
 - ③ Above selection requirements of circuit breaker size: Circuit breaker size is based on ambient temperature of 40°C when the circuit breaker is working. If the operation condition is different, please calculate according to circuit breaker specification.
- (2) Install circuit breaking device near the unit. The minimum distance between each stage of circuit breaking should be 3mm (The same for both indoor unit and outdoor unit).

4 Installation Instructions

4.1 Installation of Indoor Unit

4.1.1 Outline Dimension and Installation Spots

Equip with a service port after hanging the unit. For the convenience of maintenance, the service port should be on one side of the electric box and below unit's lower level.

GMV-NX140P/A(X1.2)-K

Unit: mm

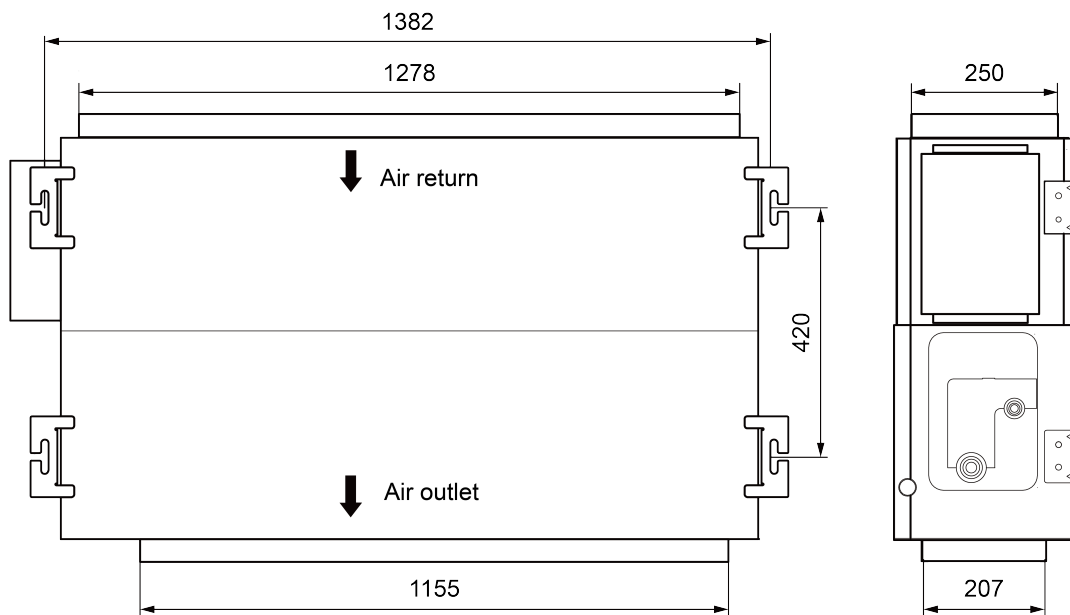

Fig.4.1.1

GMV-NX224P/A(X2.0)-M; GMV-NX280P/A(X2.5)-M; GMV-NX280P/A(X3.0)-M

Unit: mm

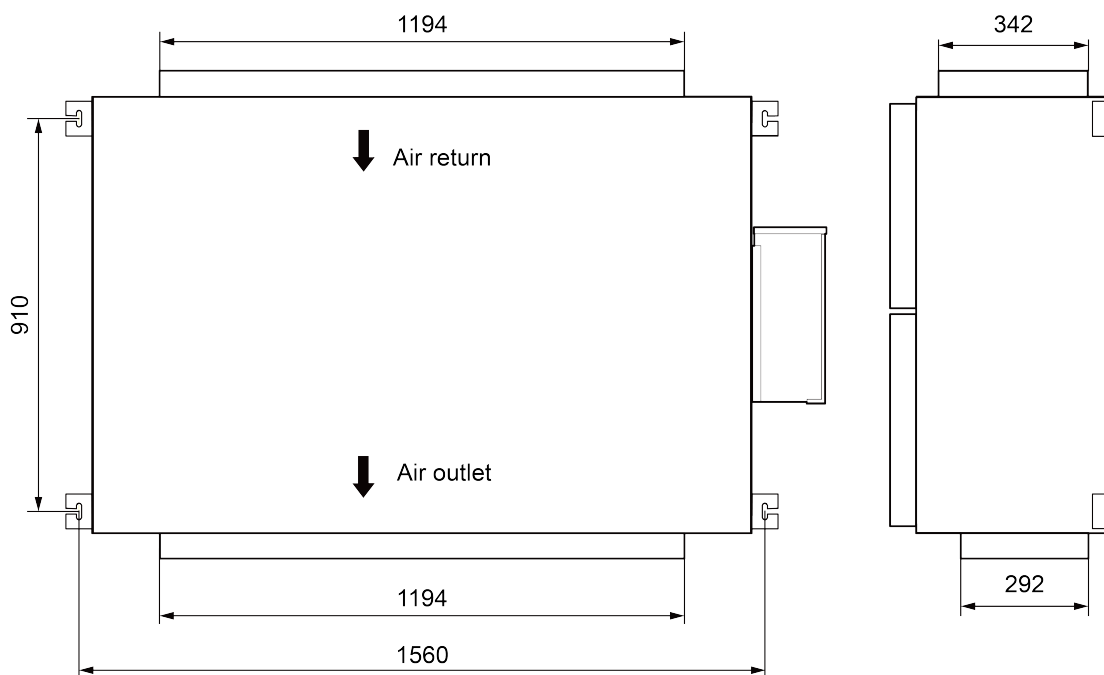

Fig.4.1.2

GMV-NX450P/A(X4.0)-M

Unit: mm

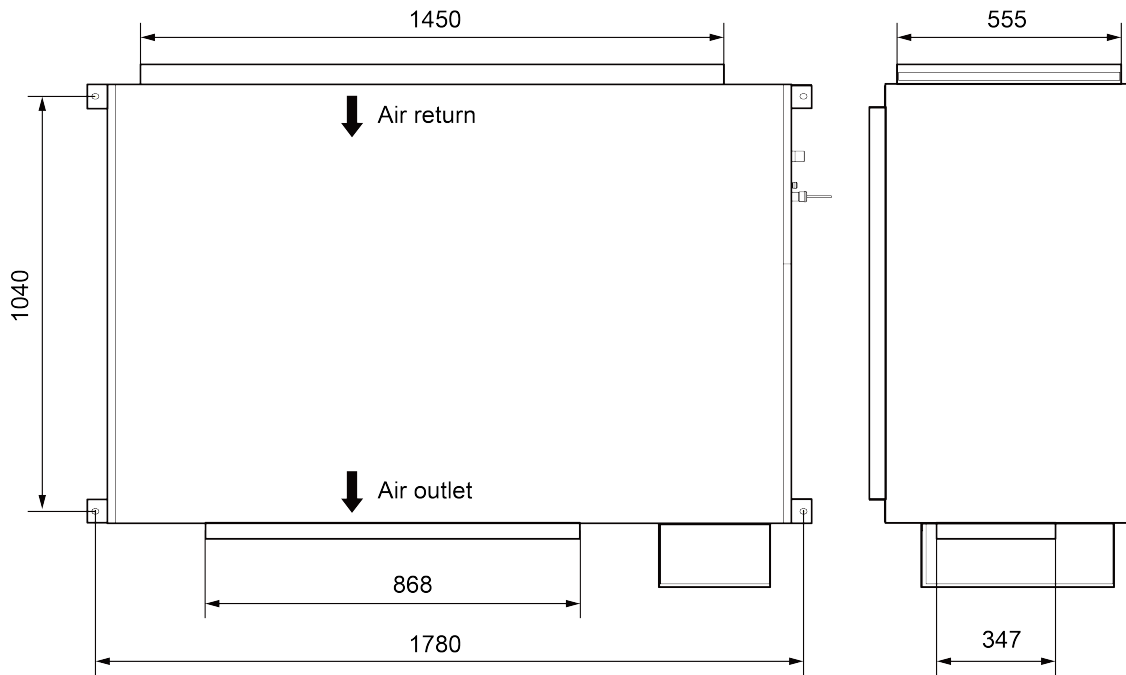

Fig.4.1.3

4.1.2 Punching of Bolt Spots and Bolt Installation

- (1) Cut out the installation paper pattern according to the hook installation dimension of unit. Place the installation paper pattern on the installation area as shown in Fig.4.1.4. Punch holes on the installation area according to the 4 spots on the paper pattern; the punching diameter may refer to the diameter of expansion bolt, about 60mm to 70mm depth, as shown in Fig.4.1.5.

Unit: mm

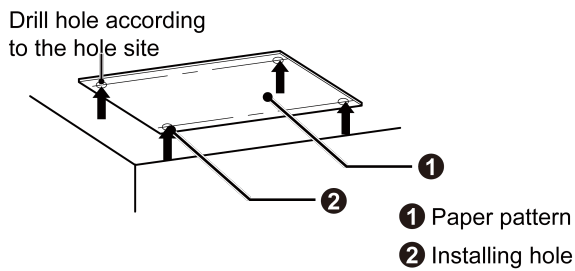

Fig.4.1.4

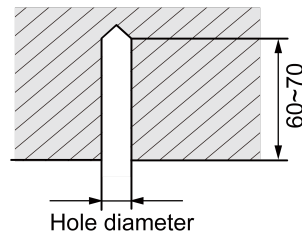

Fig.4.1.5

- (2) Insert the expansion bolt M10 into the hole and then drive the iron nail into the bolt, as shown in Fig.4.1.6.



The length of bolt can be based on the height of room. Bolt should be prepared by the user.

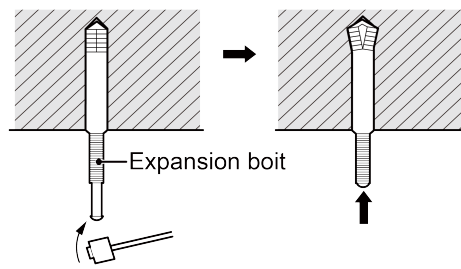

Fig.4.1.6

4.1.3 Lift the Unit

Lift up the unit to the ceiling and secure it on the bolt. Use specialized nut to secure the unit.

Unit: mm

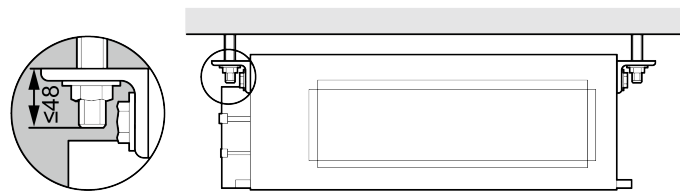

Fig.4.1.7

! NOTES!

- ① Before installation, please finish the preparation work of all pipes (connection pipe, drain pipe) and wires (wired controller wire, connection wire of IDU and ODU) that need to be connected with the indoor unit.
- ② Punch holes on the ceiling (air return opening or air outlet). Ceiling may have to be strengthened to make it level and to prevent it from vibration. You may consult user or constructor for details.
- ③ If the ceiling is not strong enough, you can install a beam bracket in a corner and secure the unit on the beam.

4.1.4 Horizontal Alignment

After the indoor unit is installed, remember to check the horizontal status of the whole unit. It should be horizontal from front to back and slant 1% from left to right, following the drainage direction, as shown in Fig.4.1.8.

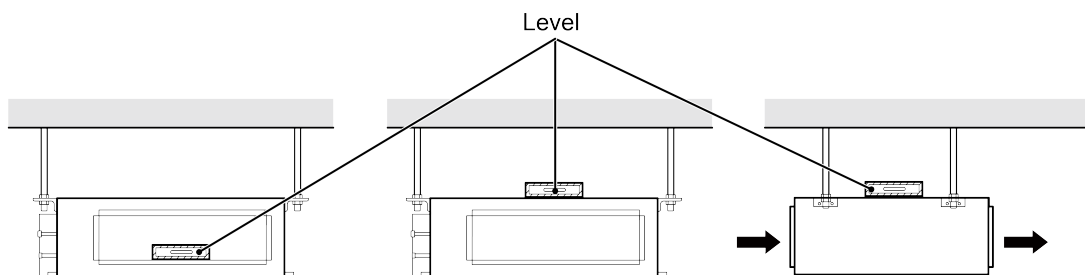

Fig.4.1.8

4.2 Pipe Connection

- (1) Direct the flaring of copper pipe to the center of screwed connection and then screw the flaring nut tight as shown in Fig.4.2.
- (2) Use a torque wrench to tighten up the flaring nut until the wrench gives out a click sound.

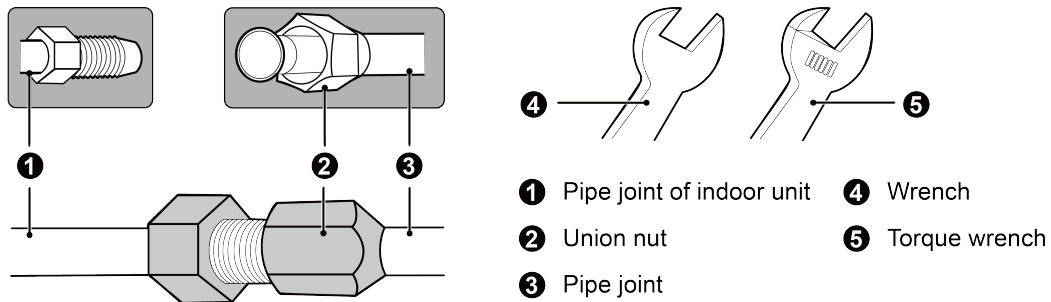

Fig.4.2

Torque for tightening nut	
Pipe diameter (mm)	Torque (N·m)
Φ6.35	15~30
Φ9.52	35~40
Φ12.7	45~50
Φ15.9	60~65
Φ19.05	70~75

- (3) The pipe should not be bent too much or it may crack. Use a pipe bender when bending the pipe.
- (4) Use a sponge to wrap the uninsulated connection pipe and the joint. Then tie it tight with a plastic tape.

4.3 Installation and Test of Drain Pipe

4.3.1 Notice for Installation of Drain Pipe

- (1) It is not allowed to connect the condensate drain pipe into waste pipe or other pipelines which are likely to produce corrosive or peculiar smell to prevent the smell from entering indoors or corrupt the unit.
- (2) It is not allowed to connect the condensate drain pipe into rain pipe to prevent rain water from pouring in and cause property loss or personal injury.
- (3) Condensate drain pipe should be connected into special drain system for air conditioner.
- (4) The drain pipe should be as short as possible and slope downward for at least 1%~2% so that condensate can drain out easily.
- (5) Size of the drainage hose must not be smaller than that of the drain pipe.
- (6) Install the drain pipe according to the following diagram and make it insulated. Improper installation will lead to water leakage and furniture and other objects may get wet.
- (7) You can buy local hard PVC pipe as drain pipe. When connecting the pipe, insert the end of PVC pipe into the drain hole and then tighten it up with a drain hose and cable tie. Do not use adhesives to connect drain hole and drain hose.

- (8) When the drain pipe is used for several equipments, the shared pipe should be about 100mm lower than the drain hole of each equipment. In this case, use thicker pipe.

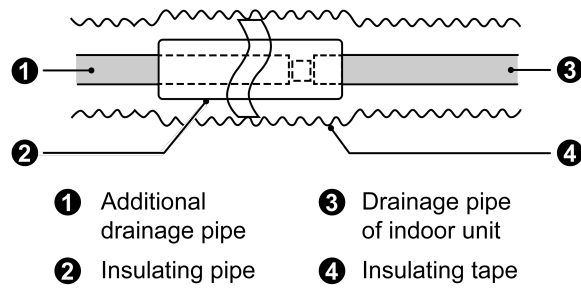

Fig.4.3.1

4.3.2 Drainage pipe installation

- (1) Insert the drain hose into the drain hole and tighten it with tapes, as shown in Fig.4.3.2. Model with water pump will be provided with drain hose, while other models please prepare the drain hose by yourself.
- (2) Tighten the pipe clamp, with the distance between screw nut and hose smaller than 4mm.

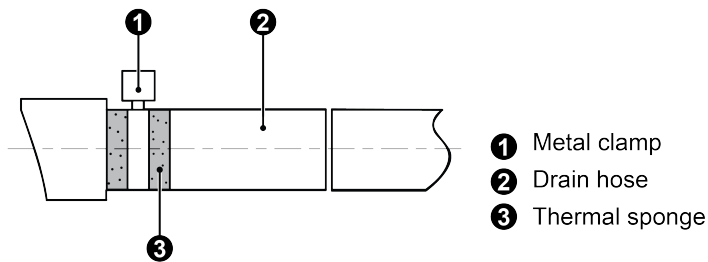

Fig.4.3.2

- (3) Use sealing plate to make the pipe clamp and hose insulated, as shown in Fig.4.3.3.

Unit: mm

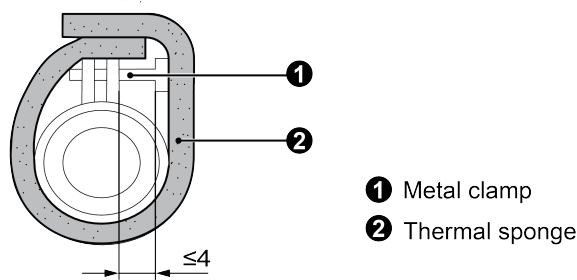

Fig.4.3.3

- (4) When connecting several drain pipes, follow the instruction as indicated in Fig.4.3.4. Choose the drain collecting pipe that matches with unit capacity.

Unit: mm

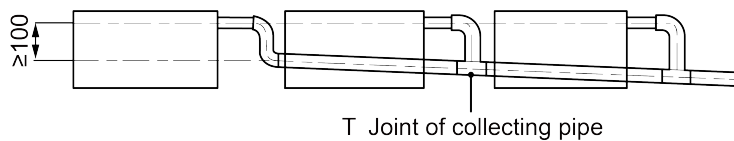

Fig.4.3.4

(5) Install the trap as shown in following Fig.4.3.5.

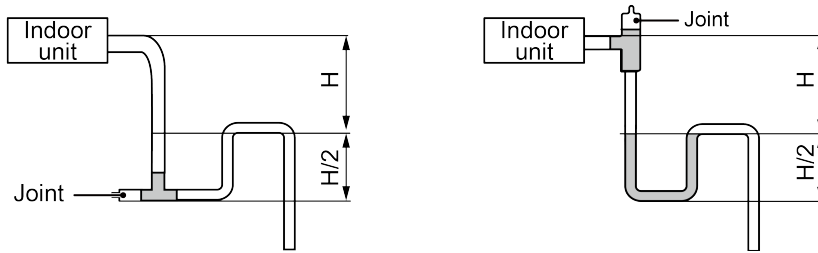

Fig.4.3.5

(6) Install one trap for each unit.

(7) Convenience for cleaning trap in the future should be considered when installing it.

(8) The horizontal pipe can be connected to vertical pipe in the same level; please select the connection way as shown in following fig.

No.1: Connection of drainage pipe joints (Fig.4.3.6).

No.2: Connection of downspout elbow (Fig.4.3.7).

No.3: Inserting pipe connection (Fig.4.3.8).

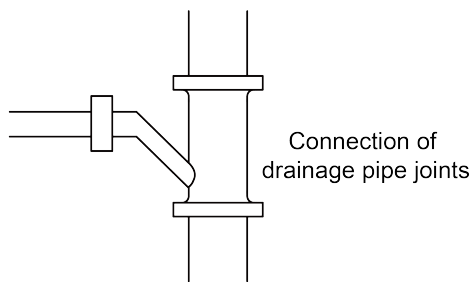

Fig.4.3.6

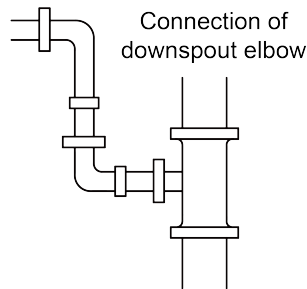

Fig.4.3.7

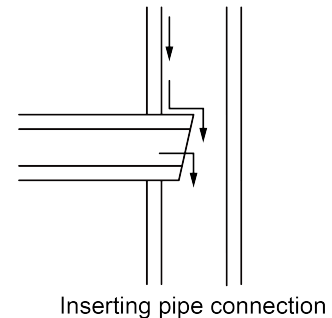

Fig.4.3.8

(9) Drain pipes should have a downward slope of at least 1% ~ 2%, in order to prevent pipes from sagging, install hanger bracket at intervals of 1000 ~ 1500mm.

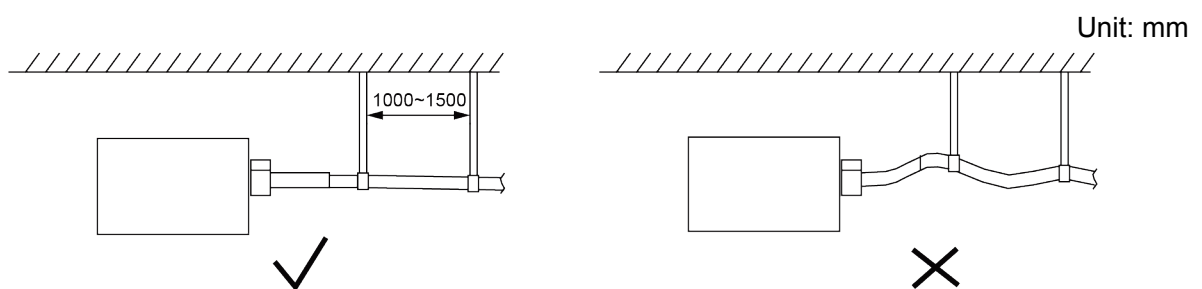

Fig.4.3.9

4.3.3 Test of Drainage System

● Models without water pump

(1) Fill some water to the water tray of indoor unit as following:

1) Connect the drain hose to the other drain connection pipe of water tray and fill about 1L water (as shown in Fig.4.3.10). (Remove the drain hose after finishing testing and then put on the plug of water tray).

2) Spray 1L water on evaporator with sprayer, as shown in Fig.4.3.11.

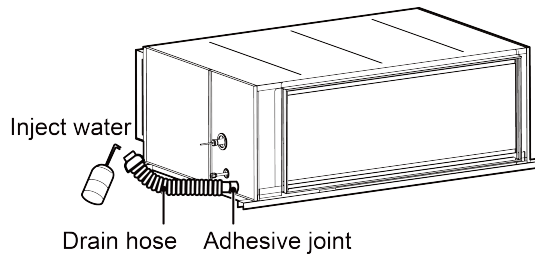

Fig.4.3.10

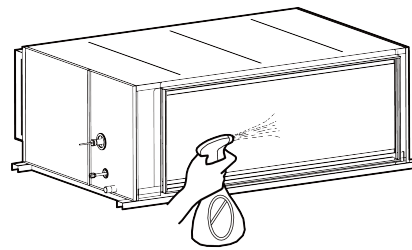

Fig.4.3.11

3) Check if the water drains smoothly from the drain pipe and check if there is water leakage on the connection pipe.

4) Arrange insulation of drain hose and pipe clamp after checking the drain system.

● Models with water pump

(1) Fill some water to the water tray of indoor unit as following:

1) Connect the drain hose to the other drain connection pipe of water tray and fill about 1L water (as shown in Fig.4.3.10). (Remove the drain hose after finishing testing and then put on the plug of water tray).

2) Spray 1L water on evaporator with sprayer, as shown in Fig.4.3.11.

(2) Start the water pump to check if water drains smoothly. The starting method of water pump is as below:

1) If project debugging of unit has been done, please set the indoor unit in cooling or dry mode. In this case, the water pump will operate automatically.

2) If communication wire is not connected, communication malfunction "C0" will occur after 60s of energizing. In this case, the water pump operates automatically. Check if the water pump drains normally through drainage port. The water pump will stop automatically after running for 10min.

(3) Check if the water drains smoothly from the drain pipe and check if there is water leakage on the connection pipe.

(4) Arrange insulation of drain hose and pipe clamp after checking the drain system.

4.4 Installation of Air Duct

! NOTES!

- ① There should be insulating layer on air-out duct, air-return duct and fresh air duct to avoid heat loss and moisture. Adhere a nail on the air duct and then add thermal sponge with a layer of tin. Fasten it with a nail cover and then seal the junction with tin tapes; you can also use other materials that have good insulation quality.
- ② Each air-out duct and air-return duct should be fixed on a pre-made board with iron frame. The junction of air duct should be well-sealed in order to prevent air leakage.
- ③ The design and construction of air duct should comply with national requirements.
- ④ The edge of air-return duct is suggested to be more than 150mm away from the wall. Add a filter to the air-return opening.

- ⑤ Please consider noise-damping and vibration damping for the design and construction of air duct. Besides, noise source must be away from people. For instance, do not have the air-return opening installed on top of the user (offices, rest area, etc.).

4.4.1 Installation of Air-out Duct

(1) Installation of the Rectangular Duct

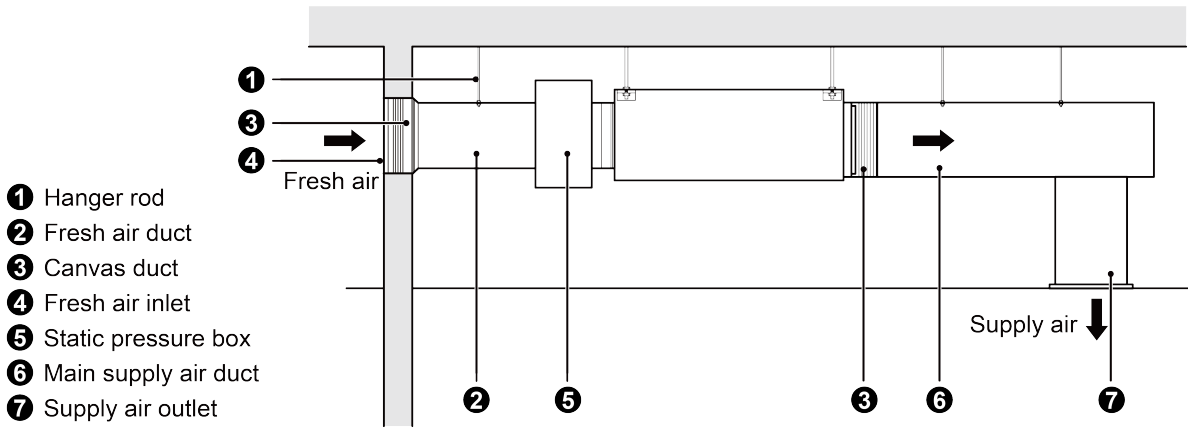

Fig.4.4.1

(2) Installation of Circular Duct

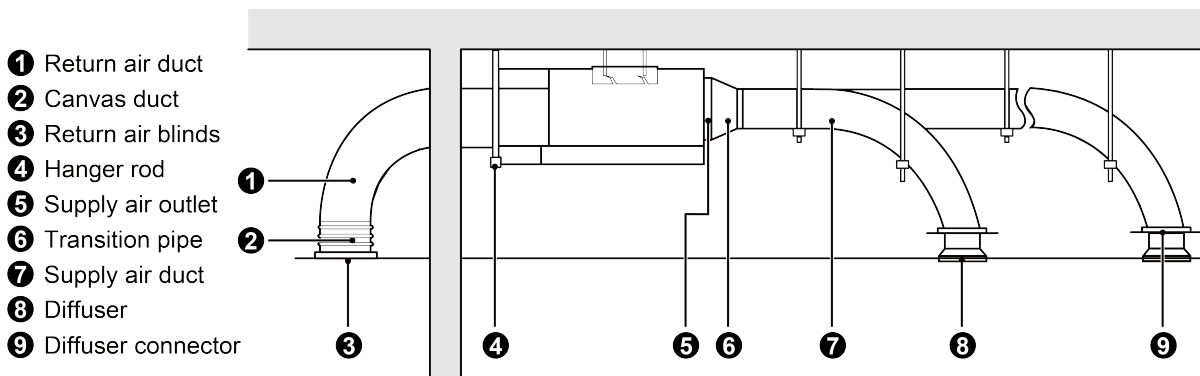

Fig.4.4.2

4.4.2 Shape and Size of Air-outlet and Air-return Opening

- (1) The following figure is applicable for the model GMV-NX140P/A(X1.2)-K

- Size of air-outlet opening

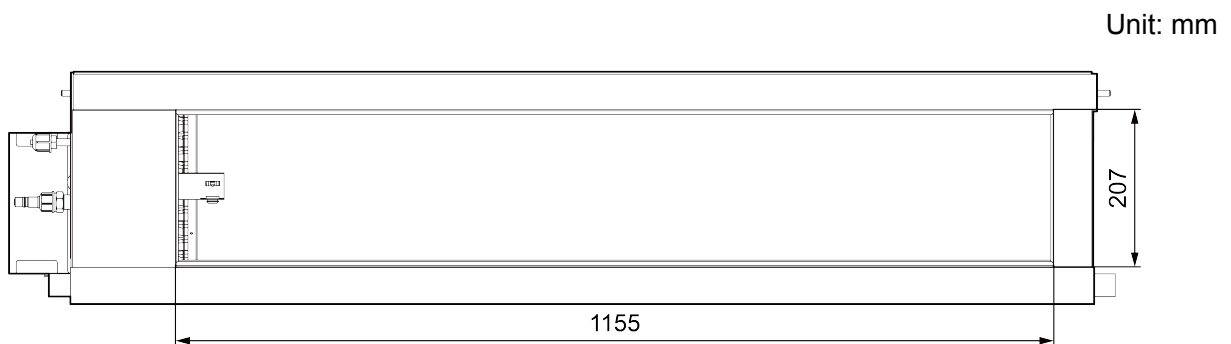

Fig.4.4.3

- Size of air-return opening

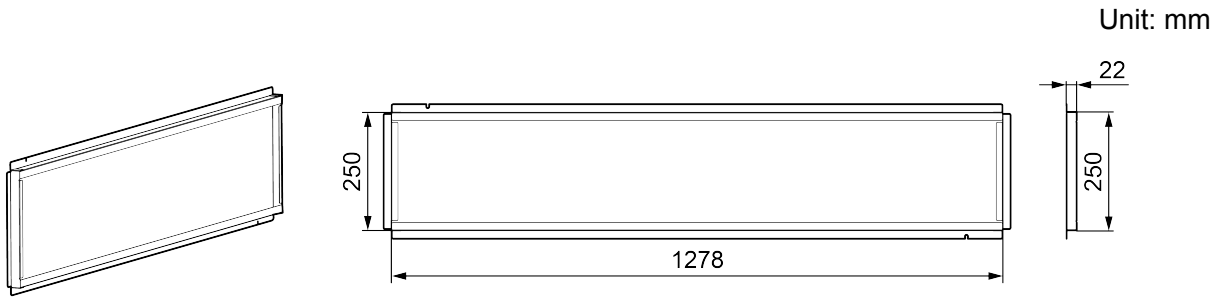

Fig.4.4.4

- (2) The following figure is applicable for the models: GMV-NX224P/A(X2.0)-M;
GMV-NX280P/A(X2.5)-M; GMV-NX280P/A(X3.0)-M

- Size of air-outlet opening

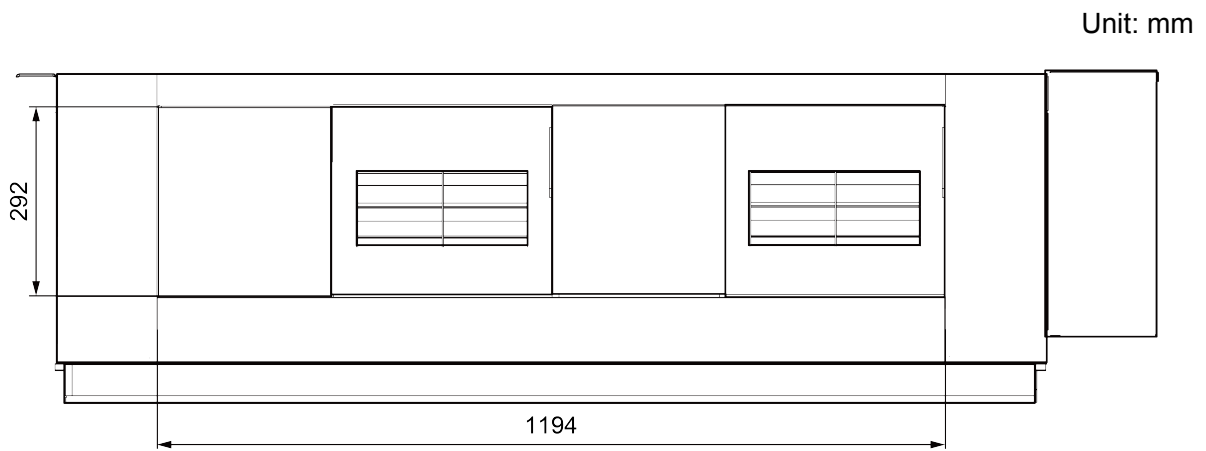

Fig.4.4.5

- Size of air-return opening

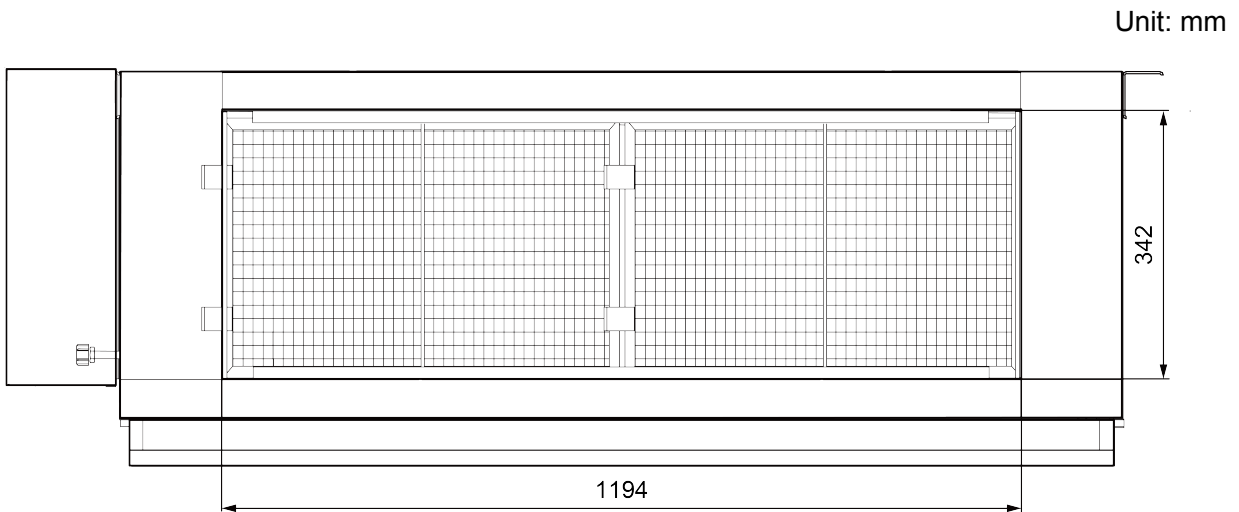

Fig.4.4.6

(3) The following figure is applicable for the models: GMV-NX450P/A(X4.0)-M

- Size of air-outlet opening

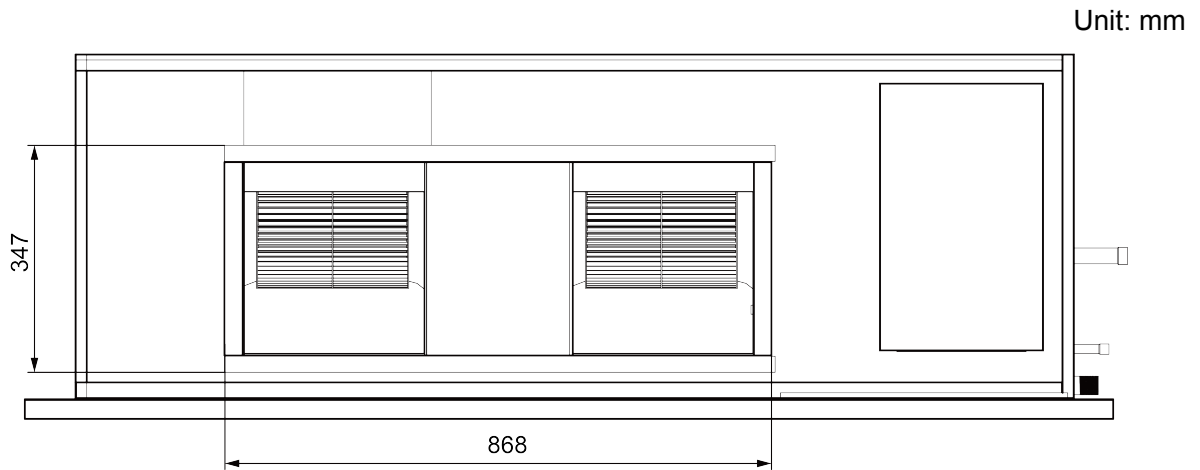

Fig.4.4.7

- Size of air-return opening

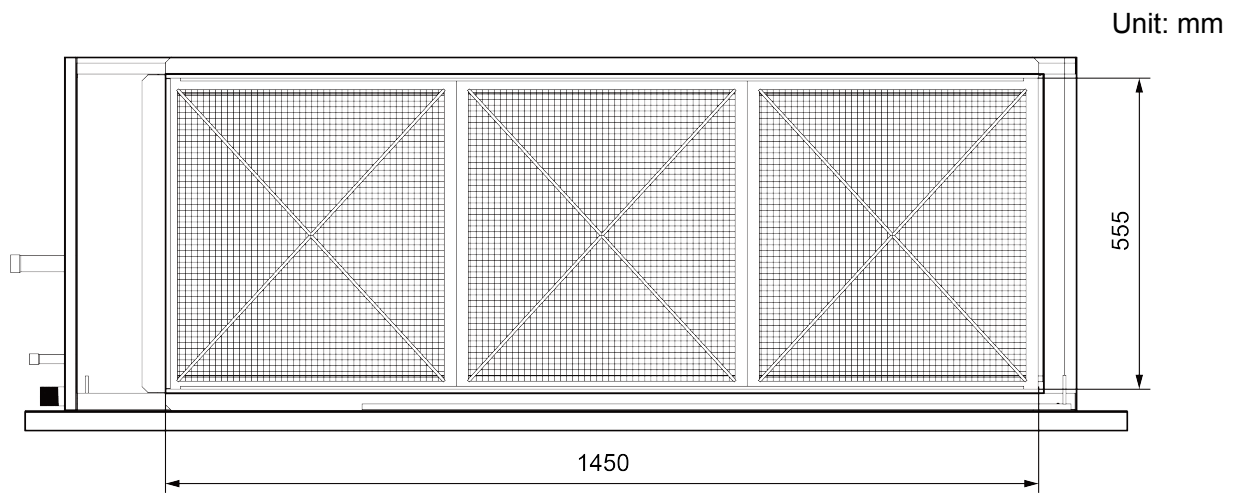

Fig.4.4.8

4.4.3 Installation of Air-return Duct

(1) Square flange is defaulted to be fitted on the back before ex-factory. Air-return cover is on the bottom, as shown in Fig.4.4.9.

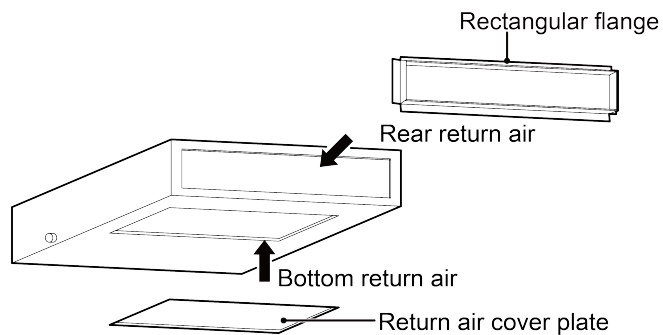

Fig.4.4.9

(2) If air return from the bottom is needed, switch the positions of square flange and air-return cover.

- (3) Use a clincher to connect air-return duct to the air-return opening of indoor unit. The other end of air-return duct connects with the air-return louver. In order to adjust the height conveniently, you can make a folded canvas duct and have it strengthened by 8# iron wire.
- (4) Air return from the bottom will produce more noise than air return from the back. So we suggest you to add a noise damper and static pressure case to lower noise if you choose air return from the bottom.
- (5) Select the appropriate installation way based on actual construction and maintenance needs, as shown in Fig.4.4.10.

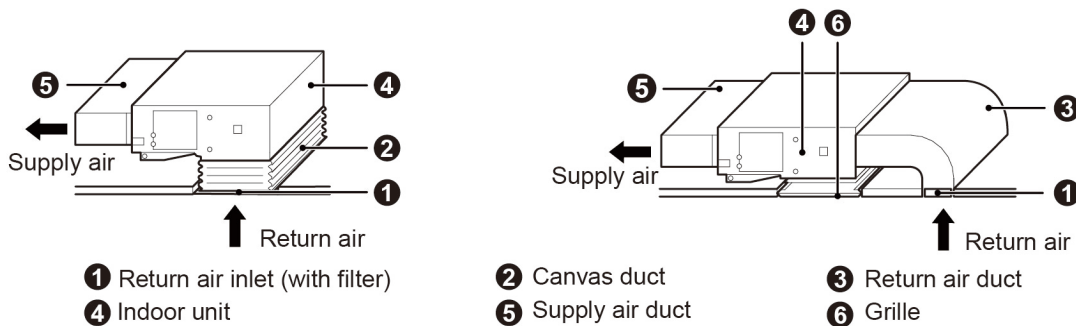

Fig.4.4.10

4.5 Installation of Wired Controller

Please refer to User Manual of Wired Controller for the installation details.

NOTE!

When installation is finished, the unit must be tested and debugged before operation. Please refer to Instruction Manual of ODU for auto addressing and debugging details.

5 Wiring Work

NOTES!

- ① For personal safety, the air conditioner must be properly grounded.
- ② Read carefully the voltage indicated on the nameplate before connecting wires. Then connect wires according to the wiring diagram. Improper wiring will lead to abnormal operation or damage the unit.
- ③ Power capacity should be large enough. Sectional area of room wires should be above 2.5mm².
- ④ For unit's power supply, please use specialized branch circuit and specialized power socket.
- ⑤ All wiring must comply with standards to ensure safe and correct operation.
- ⑥ Install specialized branch circuit breaker according to related laws and regulations and electrical standards.
- ⑦ All wiring must use pressure terminal or single wire. Multi-twisted wire that connects directly to the wiring board may cause fire hazard.
- ⑧ Keep the wires away from refrigerant pipe, compressor and fan.

- ⑨ Do not alter the inner wires of air conditioner. Manufacturer does not assume responsibility for damage or abnormal operation due to this reason.
- ⑩ If the unit is installed in places with strong electromagnetic interference, it's recommended to use twin-twisted shield wire. During wire connection, please pay attention that the metal shield layer of the twin-twisted wire must be grounded (outer case) in order to prevent the unit from electromagnetic interference.
- ⑪ Communication line should be separated from the power cord and the connection wire of IDU and ODU.
- ⑫ If the project needs higher static pressure, you can set it through the wired controller.
- ⑬ The appliance must be fitted with means for disconnection from the supply mains having a contact separation in all poles that provide full disconnection under overvoltage category III conditions, and these means must be incorporated in the fixed wiring in accordance with the wiring rules.
- ⑭ The appliance shall be installed in accordance with national wiring regulations.

5.1 Connection of Wire and Patch Board Terminal

(1) The connection of wire (as shown in Fig.5.1.1)

- 1) Strip about 25mm insulation of the wire end by stripping and cutting tool.
- 2) Remove the wiring screws on the terminal board.
- 3) Shape the tail of wire into ring by needle nose plier, and keep the gauge of ring in accordance with screw.
- 4) Use the screwdriver for tightening the terminal.

(2) The connection of stranded wire (as shown in Fig.5.1.2)

- 1) Strip about 10mm insulation of the end of stranded wire by stripping and cutting tool.
- 2) Loosen the wiring screws on terminal board.
- 3) Insert the wire into the ring tongue terminal and tighten by crimping tool.
- 4) Use the screwdriver for tightening the terminal.

Unit: mm

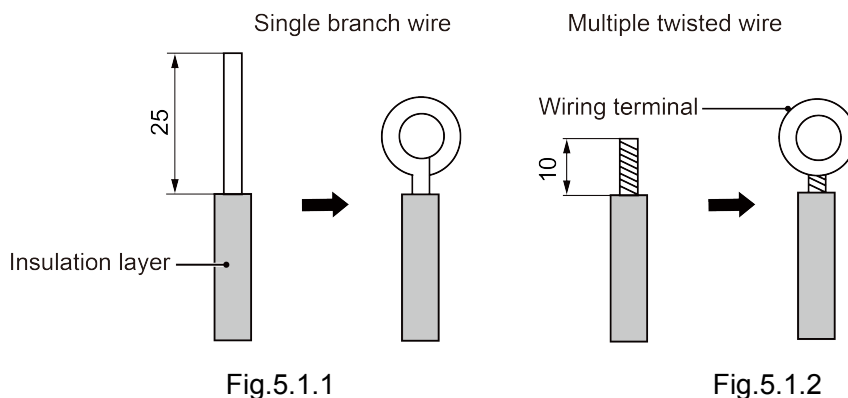

5.2 Power Cord Connection

NOTES!

- ① Every unit should be equipped with a circuit breaker for short-circuit and overload protection.
- ② During operation, all indoor units connected to the same outdoor unit system must be kept energized status. Otherwise, the unit can't operate normally.

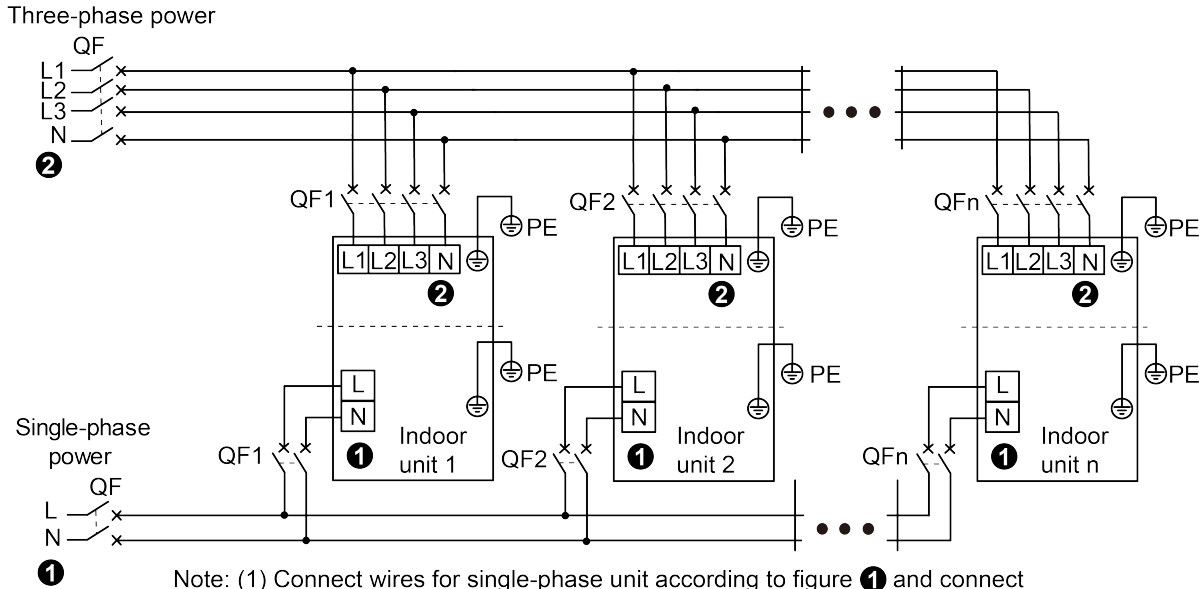

- Note: (1) Connect wires for single-phase unit according to figure ① and connect wires for three-phase unit according to figure ②. As for some areas where there's no neutral wire, please refer to the wiring diagram of unit for details.
- (2) The maximum connection quantity "n" for indoor unit is decided by the capacity of outdoor unit. Please refer to the unit capacity of unit for details.

Fig.5.2

- (1) Detach the electric box lid.
- (2) Let the power cord pass through the wiring through-holes.
- (3) Connect wires according to Fig. 5.2.
- (4) Fix the power cord with wiring clamp.

5.3 Connection of Communication Line of IDU and ODU

- (1) Detach the electric box lid.
- (2) Let the Communication cable pass through the wiring through-holes.
- (3) Connect the communication wire to terminal D1 and D2 of indoor 4-bit wiring board, as shown in Fig.5.3.1.

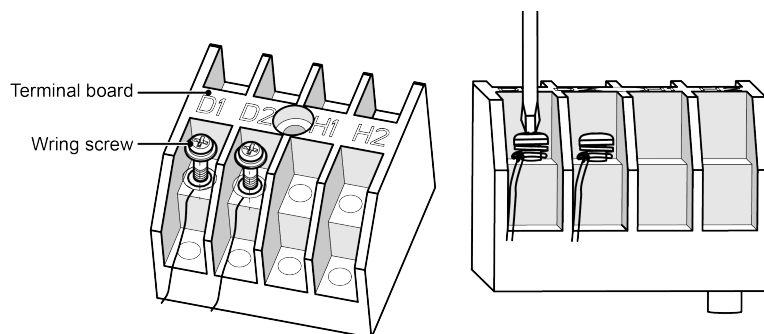

Fig.5.3.1

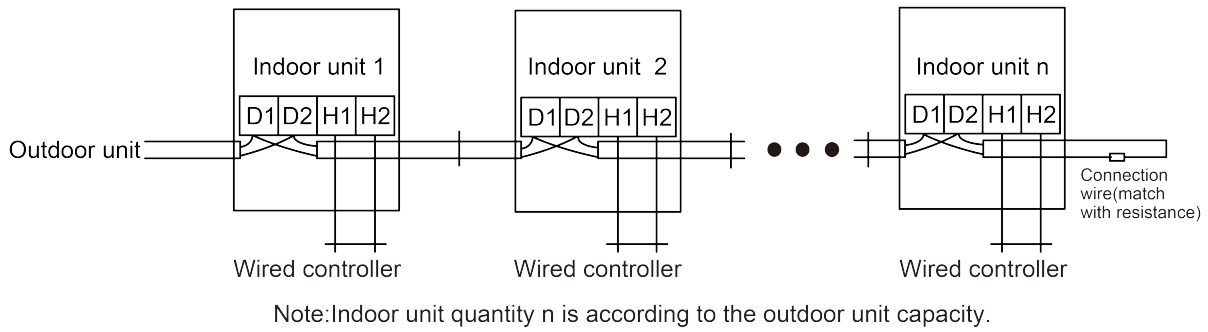

Fig.5.3.2

- (4) Fix the communication cable with clamp of electric box.
- (5) For more reliable communication, make sure connect the terminal resistor to the most downstream IDU of the communication bus (terminals D1 and D2), as shown in Fig.5.3.2, terminal resistor is provided with each ODU.

5.4 Connect Communication Wire of Wired Controller

- (1) Open electric box cover of indoor unit.
- (2) Let the communication wire go through the rubber ring.
- (3) Connect the communication wire to terminal H1 and H2 of indoor 4-bit wiring board.
- (4) Fix the communication wire with wire clip on the electric box.
- (5) Wiring instructions of remote receiving light board and wired controller:
 - 1) Fig.5.4.1 shows the installation of wired controller.

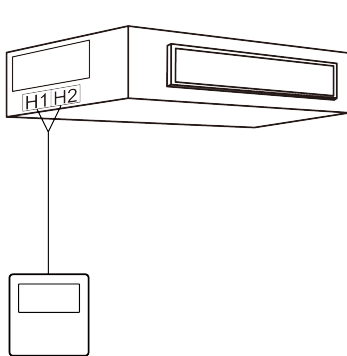

Fig.5.4.1

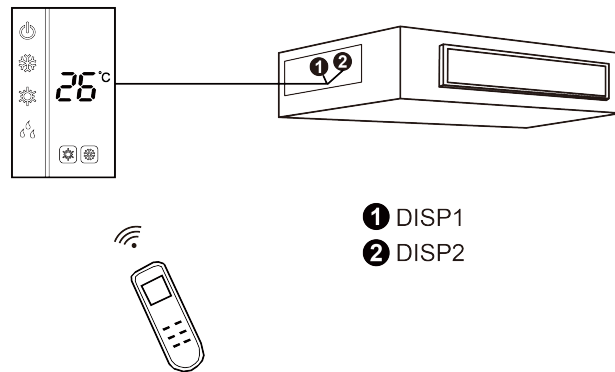

Fig.5.4.2

- 2) Fig.5.4.2 shows the installation of remote controller.
- 3) Wired controller and receiving light board can be installed at the same time. When operating through a remote controller, both wired controller and the receiving light board can receive the signals, as shown in Fig.5.4.3.

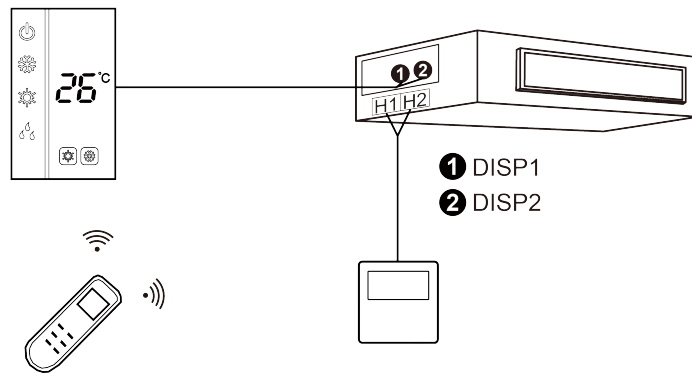

Fig.5.4.3

5.5 Illuminate for Connection of Wired Controller and Indoor Units Network

- (1) Communication wire of indoor unit and outdoor unit (or indoor unit) is connected to D1, D2.
- (2) Wired controller is connected to H1, H2.
- (3) One indoor unit can connect two wired controllers that must be set as master one and slave one.
- (4) One wired controller can control 16 indoor units in maximum at the same time. (as shown in Fig.5.5)

! NOTES!

- ① When the wired controller is controlling multiple indoor units at the same time, the indoor units must be of the same model. Fresh air indoor unit can not share the same wired controller with other types of VRF indoor unit.
- ② When two wired controllers are controlling the indoor units, you need to set an address for each wired controller. Address No.1 refers to master wired controller while address No.2 refers to sub-master wired controller. They should not share the same address. For specific setting methods, please refer to installation manual of wired controller.
- ③ If connecting the fresh air indoor unit with wired controller for operation, fresh air indoor unit code "FAP" will be displayed. For specific operation methods, please refer to instruction manual of wired controller.

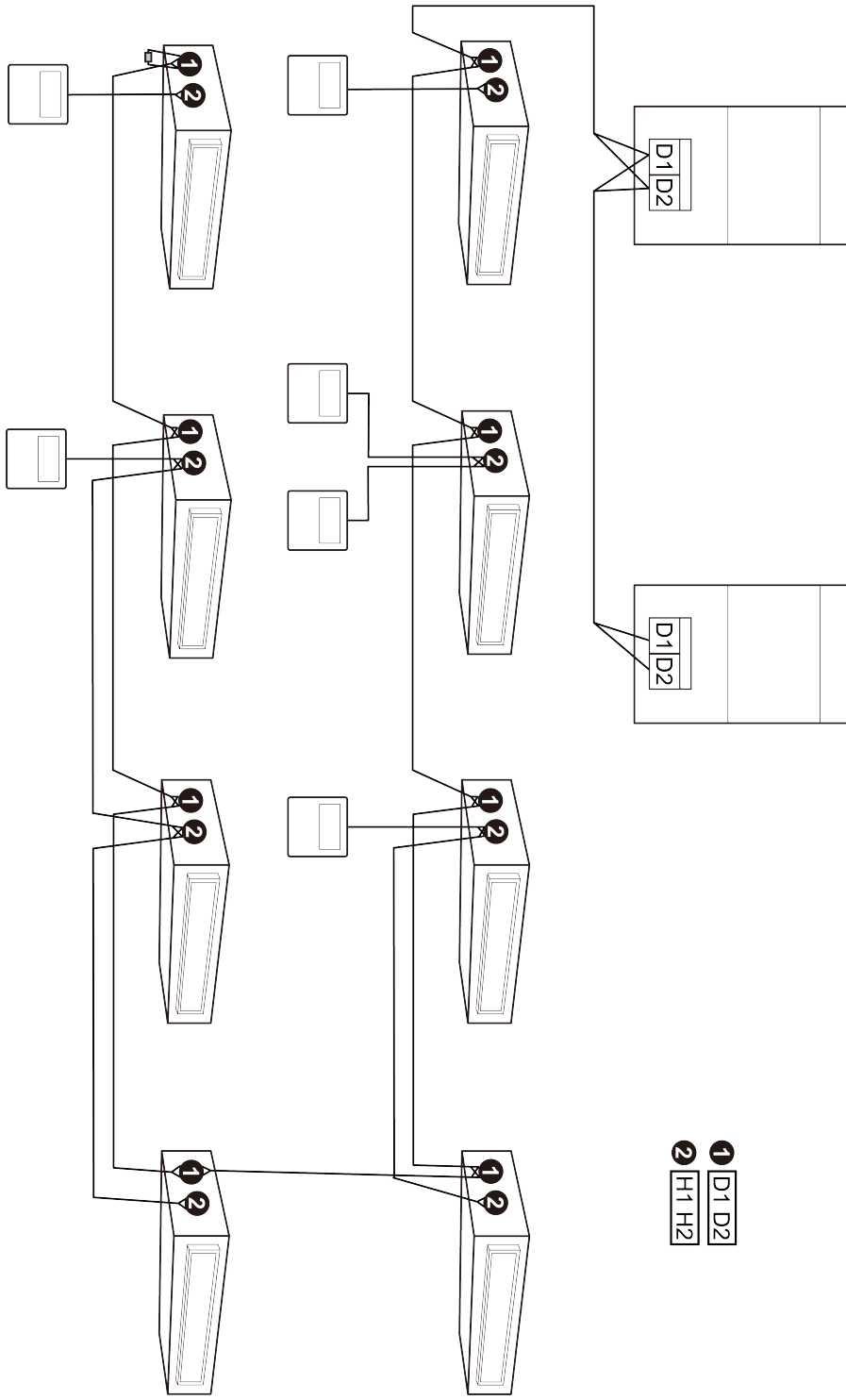

Fig.5.5

6 Routine Maintenance



WARNING!

- ① Do not turn off the unit and cut off the main power supply when cleaning the air conditioner to avoid electric shock or injury.
- ② Stand at solid table when cleaning the unit.
- ③ Do not clean the unit with hot water which temperature is higher than 45°C to prevent fading or deformation.
- ④ Do not dry the filters by fire, or it may catch fire or become deformed.
- ⑤ Clean the filter with a wet cloth dipped in neutral detergent.
- ⑥ Please contact after-sales service staff if there is abnormal situation.

6.1 Cleaning of Filter

- (1) Remove the filters from inlet of IDU. Use a vacuum cleaner to remove dust. If the filters are dirty, wash them with warm water and mild detergent, and dry the filters in the shade.
- (2) If the unit used in the environment with much dust, please clean it regularly. (Usually once every two weeks).

6.2 Maintenance before the Seasonal Use

- (1) Check if the air inlet and air outlet of indoor and outdoor unit are blocked.
- (2) Check if securely grounded.
- (3) Check if all the power cord and communication cable are securely connected.
- (4) Check if any error code displayed after energized.

6.3 Maintenance after the Seasonal Use

- (1) Set the unit in fan mode for half a day in a sunny day to dry the inner part of unit.
- (2) When the unit won't be used for a long time, please cut off power supply for energy saving; the characters on the wired controller screen will disappear after cutting off the power supply.

7 The Table of Error Codes for Indoor Unit

Error Code	Content	Error Code	Content	Error Code	Content
L0	Indoor Unit Error	LA	Indoor Units Incompatibility Error	d9	Jumper Cap Error
L1	Indoor Fan Protection	LH	Low Air Quality Warning	dA	Indoor Unit Network Address Error
L2	E-heater Protection	LC	ODU-IDU Incompatibility Error	dH	Wired Controller PCB Error
L3	Water Full Protection	d1	Indoor Unit PCB Error	dC	Capacity DIP Switch Setting Error.
L4	Wired Controller Power Supply Error	d3	Ambient Temperature Sensor Error	dL	Outlet Air Temperature Sensor Error
L5	Freeze protection	d4	Inlet Pipe Temperature Sensor Error	dE	Indoor Unit CO ₂ Sensor Error
L7	No Master Indoor Unit Error	d6	Outlet Pipe Temperature Sensor Error	C0	Communication Error

Error Code	Content	Error Code	Content	Error Code	Content
L8	Power Insufficiency Protection	d7	Humidity Sensor Error	AJ	Filter Cleaning Reminder
L9	Quantity Of Group Control Indoor Units Setting Error	d8	Water Temperature Error	o1	Low bus bar voltage of indoor unit
o2	High bus bar voltage of indoor unit	o3	IPM Module Protection of Indoor Unit	o4	Failure Startup of Indoor Unit
o5	Overcurrent Protection of Indoor Unit	o6	Current Detection Circuit Malfunction of Indoor Unit	o7	Desynchronizing Protection of Indoor Unit
o8	Communication Malfunction of Indoor Unit's Drive	o9	Communication Malfunction of Main Mater of Indoor Unit	oA	High temperature of Indoor Unit's Module
ob	Malfunction of Temperature Sensor of Indoor Unit's Module	oC	Charging Circuit Malfunction of Indoor Unit	o0	Other Drive Malfunction
db	Special Code: Field Debugging Code				

8 Troubleshooting

If your air conditioner is not working well, please check the following table first before asking for service:

Phenomenon	Troubleshooting
The unit can't start	<ul style="list-style-type: none"> ①Power supply is not connected. ②Circuit breaker tripping caused by leakage of electricity. ③Input voltage is too low. ④Operation button is off. ⑤Error of control loop.
The unit stops after running for a while	<ul style="list-style-type: none"> ①There is obstacle in front of condenser. ②Error of control loop. ③Perform cooling when outdoor ambient temperature is higher than 43°C.
Poor cooling effect	<ul style="list-style-type: none"> ①The filter is dirty or blocked. ②Too heavy heat load of room(e.g. too many people). ③Door or windows is open. ④Air inlet and outlet of IDU are blocked. ⑤Set temperature is too high or refrigerant leaks. ⑥The performance of room temperature sensor gets worse.
Poor heating effect	<ul style="list-style-type: none"> ①The filter is dirty or blocked. ②Door or window is open. ③Set temperature is too low. ④Refrigerant leaks. ⑤Outdoor ambient temperature is lower than -5°C. ⑥Error of control circuit.
Indoor fan doesn't start up during heating	<ul style="list-style-type: none"> ①Position of tube temperature sensor is improper. ②Tube temperature sensor is not inserted well. ③Wiring of tube temperature sensor breaks off. ④Electrical leakage of capacitor.



If air conditioner still fails to work normally after checking and handling as described above, please stop using it immediately and contact local service center for assistance.

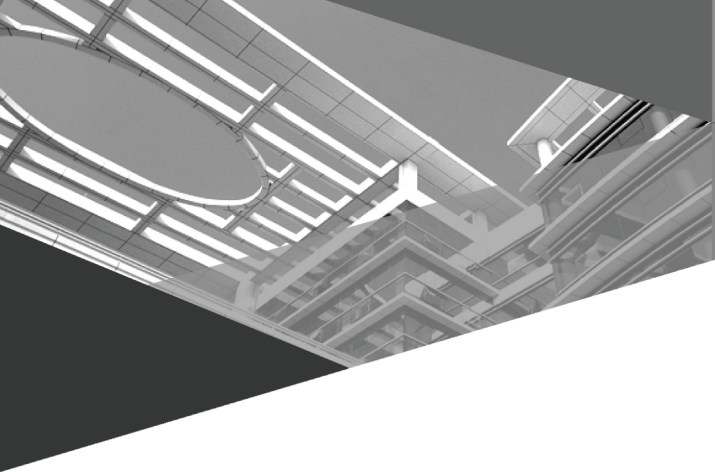

GREE ELECTRIC APPLIANCES, INC. OF ZHUHAI

Add: West Jinji Rd, Qianshan, Zhuhai, Guangdong, China, 519070

Tel: (+86-756) 8522218

Fax: (+86-756) 8669426

E-mail: global@cn.gree.com www.gree.com



66174100047